



Application

- HVAC: Circulation of hot water, boiler mix-flow, temperature mix-flow, intermittent heat supply, etc
- Air conditioning system: Cooling water circulation
- Water supply system: Filtration and transfer at waterworks; Pressure boosting in main pipe
- Industrial applications: Washing & cleaning systems, boiler feeding, cooling water circulation, water treatment systems, and auxiliary systems
- Fire-fighting system

Pump

- Flow: up to 760 m³/h
- Head: up to 85 m
- Power range: 0.37 – 132 kW
- Liquid temperature: 0°C – +90°C
- Max ambient temperature: + 40°C
- Max operation pressure: 16 bar
- Altitude: up to 1000 m

Motor

- Closed construction
- Insulation class: F
- Protection class: IP 55
- IE 2 motor as standard. IE 3 motor is available on request

Flange

- EN 1092 and DIN 2576 standard

Identification Codes

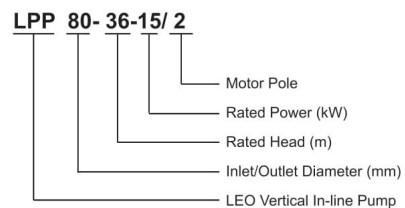

Ambient Temperature

Max. Ambient temperature: +40°C. Ambient temperature above 40°C, or installation at altitude of more than 1000 m above sea level, require the use of an oversize motor. Because of low air density and poor cooling effects, the motor output power P2 will be decreased. See the picture.

For example, when the pump is installed at altitude of more than 3500 m above sea level, P2 will be decrease to 88%. When the ambient temperature is 70°C, P2 will be decreased to 78%.

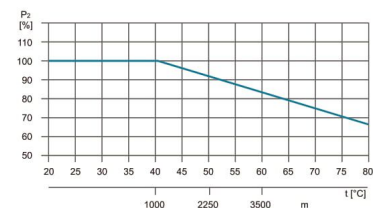

Materials Table

No.	Part	Materials
1	Pump body	Cast iron
2	Impeller	Cast iron
3	Mechanical seal	Carbon/Silicon carbide
4	Pump shaft	Steel/AISI 304
5	Clamp ring	Steel
6	Motor base	Cast iron
7	Motor	



How to Read The Curve Charts

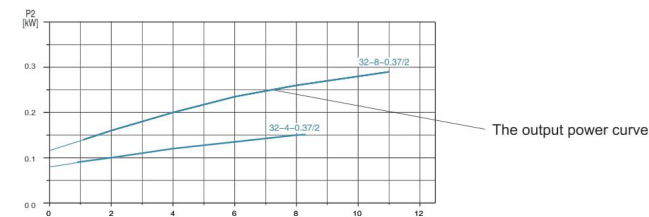
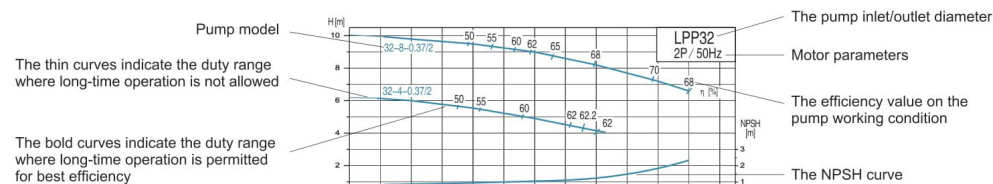

Guidelines to Performance Curves

Tolerances to ISO 9906, Annex A. Measurements have been made with airless water at a temperature of 20°C and kinematic viscosity of 1mm²/s. To avoid overheating of the motor, the pump should not be use against a high head for a long time.

Model	Power P ₂ (kW)	Rated Speed n (r/min)	Rated Flow Q (m ³ /h)	Rated Head (m)	Max. Flow Q (m ³ /h)	Max. Head H(m)	NPSH _c (m)
LPP32-8-0.37/2	0.37	2900	8.5	8	11	10	2
LPP32-4-0.37/2	0.37	2900	7.5	4	8.5	6	2
LPP32-31/3/2	3	2900	20	31	24	37	2
LPP32-26-2.2/2	2.2	2900	18	26	21	32	2
LPP32-21-1.5/2	1.5	2900	14	21	18.5	26	2
LPP32-16-1.1/2	1.1	2900	12	16	16	20	2
LPP32-50-5.5/2	5.5	2900	12.5	50	20	53.5	2.5
LPP32-40-4/2	4	2900	12.5	40	20	46	2.5
LPP40-20.5-1.5/2	1.5	2900	12	20.5	20	25	2
LPP40-17.5-1.1/2	1.1	2900	12	17.5	18	21	2
LPP40-13-0.75/2	0.75	2900	10	13	15.5	16.5	2
LPP40-31-4/2	4	2900	26	31	38	35	2
LPP40-24.5-3/2	3	2900	24	24.5	36	28	2
LPP40-20.5-2.2/2	2.2	2900	23	20.5	35	25	2
LPP50-24-3/2	3	2900	30	24	36	29	2
LPP50-21-2.2/2	2.2	2900	24	21	35	25	2
LPP50-16-1.5/2	1.5	2900	22	16	32	19	2
LPP50-12-1.1/2	1.1	2900	20	12	26	15	2
LPP50-34-5.5/2	5.5	2900	35	34	50	42	2
LPP50-28-4/2	4	2900	30	28	43	33	2
LPP50-50-5.5/2	5.5	2900	12.5	50	26	54	5
LPP50-40-4/2	4	2900	12.5	40	26	42	5
LPP50-35-3/2	3	2900	12.5	35	20	40	5
LPP50-80-11/2	11	2950	12.5	80	26	81.5	2.5
LPP50-70-7.5/2	7.5	2950	12.5	70	20	73	2.5
LPP50-60-7.5/2	7.5	2950	12.5	60	20	63	2.5
LPP50-81-22/2	22	2950	50	81	59	88	4.8
LPP50-70-18.5/2	18.5	2950	50	70	59	78	4.8
LPP50-60-15/2	15	2950	50	60	59	67	4.8
LPP65-35-7.5/2	7.5	2900	55	35	70	39	2.5
LPP65-28-5.5/2	5.5	2900	50	28	70	30	2.5
LPP65-21-4/2	4	2900	45	21	60	24	2.5
LPP65-17-3/2	3	2900	40	17	56	20	2.5
LPP65-14-2.2/2	2.2	2900	35	14	50	17	2
LPP65-56-18.5/2	18.5	2950	70	56	86	61	3
LPP65-49-15/2	15	2950	65	49	80	53	3
LPP65-40-11/2	11	2950	56	40	80	43	2.5
LPP80-20-5.5/2	5.5	2900	70	20	90	25	3.5
LPP80-17-4/2	4	2900	64	17	79	21	3.2
LPP80-14-3/2	3	2900	55	14	75	17	3
LPP80-10.5-2.2/2	2.2	2900	52	10.5	70	14	3
LPP80-8.5-1.5/2	1.5	2900	45	8.5	65	10.5	3
LPP80-35-15/2	15	2950	110	35	130	42	4.5
LPP80-28-11/2	11	2950	100	28	125	35	4.5
LPP80-21.5-7.5/2	7.5	2950	90	21.5	119	28	4
LPP80-80-22/2	22	2950	50	80	70	86	2.8
LPP80-70-18.5/2	18.5	2950	45	70	65	75	2.8
LPP80-60-15/2	15	2950	40	60	60	63	2.8
LPP100-32-22/2	22	2950	170	32	190	43	6.5
LPP100-30-18.5/2	18.5	2950	160	30	179	38	6.5
LPP100-24-15/2	15	2950	150	24	180	31	6.5
LPP100-20-11/2	11	2950	135	20	175	28	6.5
LPP100-80-37/2	37	2950	100	80	130	86	3.5
LPP100-70-30/2	30	2950	90	70	120	76	3.5

Model	Power P ₂ (kW)	Rated Speed n (r/min)	Rated Flow Q (m ³ /h)	Rated Head (m)	Max. Flow Q (m ³ /h)	Max. Head H(m)	NPSH _c (m)
LPP100-60-22/2	22	2950	80	60	96	64	3.5
LPP100-50-22/2	22	2950	100	50	140	56	3.5
LPP100-44-18.5/2	18.5	2950	90	44	140	47	3.5
LPP100-38-15/2	15	2950	85	38	130	43	3.5
LPP125-50-30/2	30	2950	160	50	190	58	5.5
LPP125-44-30/2	30	2950	150	44	190	52	5.5
LPP125-37.5-22/2	22	2950	135	37.5	180	45	5.5
LPP80-28-11/4	11	1480	90	28	120	31	2
LPP80-22-7.5/4	7.5	1480	80	22	100	24	2
LPP80-19-5.5/4	5.5	1480	68	19	80	21.5	2
LPP100-32-22/4	22	1480	170	32	213	36	2
LPP100-30-18.5/4	18.5	1480	160	30	208	33	2
LPP100-25-15/4	15	1480	155	25	186	28	2
LPP100-21-11/4	11	1480	130	21	170	23	2
LPP100-16-7.5/4	7.5	1480	115	16	150	19	2
LPP125-35-30/4	30	1480	200	35	279	40	2.5
LPP125-31-22/4	22	1480	170	31	260	34	2
LPP125-28-18.5/4	18.5	1480	155	28	249	30	2
LPP125-24-15/4	15	1480	140	24	230	27	2
LPP125-19-11/4	11	1480	125	19	209	22	2
LPP150-33-37/4	37	1480	300	33	390	37	3.5
LPP150-29-30/4	30	1480	280	29	360	32	3.5
LPP150-24.5-22/4	22	1480	250	24.5	324	28	3
LPP150-21.5-18.5/4	18.5	1480	230	21.5	290	23	3
LPP150-50-45/4	45	1480	200	50	260	52	2
LPP150-40-37/4	37	1480	200	40	260	44	2
LPP150-33-30/4	30	1480	200	33	300	36	3.5
LPP150-25-22/4	22	1480	200	25	260	28	3.5
LPP150-25-30/4	30	1480	300	25	360	31	4.1
LPP150-21-18.5/4	18.5	1480	200	21	260	24	3
LPP150-17-15/4	15	1480	200	17	260	20	3
LPP150-12.5-11/4	11	1480	200	12.5	260	16	3
LPP200-34-75/4	75	1480	600	34	659	41	5.5
LPP200-28-55/4	55	1480	560	28	656	32	5.5
LPP200-22.5-45/4	45	1480	521	22.5	662	27	5.25
LPP200-55-75/4	75	1480	300	55	420	61	5.5
LPP200-44-55/4	55	1480	280	44	360	50	5.5
LPP200-38-45/4	45	1480	262	38	340	45	5.5
LPP200-32-37/4	37	1480	245	32	320	38	5.5
LPP250-50-110/4	110	1480	550	50	715	58	4.7
LPP250-44-90/4	90	1480	500	44	650	50	4.7
LPP250-37-75/4	75	1480	460	37	645	44	4.7
LPP200-36-75/4	75	1480	500	36	650	40	4.8
LPP200-18-37/4	37	1480	500	18	600	23	5.4
LPP200-15-30/4	30	1480	500	15	600	20	5.4
LPP200-18-18.5/4	18.5	1480	300	18	390	20	3.5
LPP200-15-15/4	15	1480	300	15	390	18	3.5
LPP250-50-132/4	132	1480	630	50	760	60	5.8
LPP250-40-110/4	110	1480	630	40	760	53	5.8

Hydraulic Performance Curves

LPP40	2900r/min
--------------	------------------

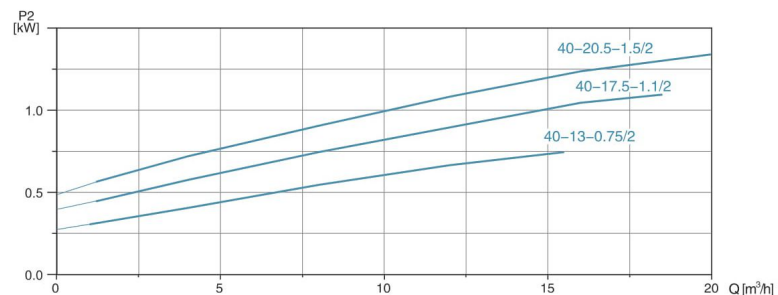
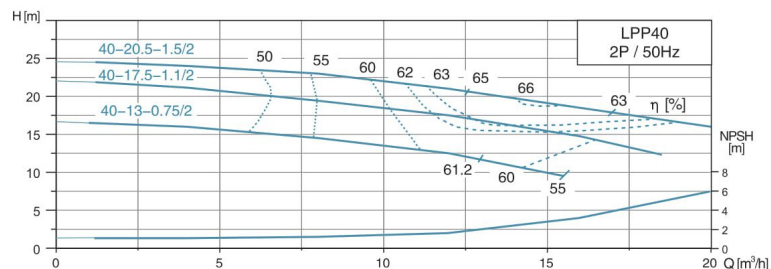

Dimension Drawing

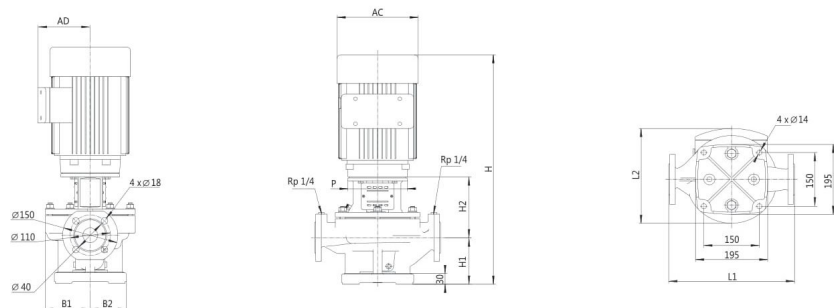

Model	L1 (mm)	L2 (mm)	H (mm)	H1 (mm)	H2 (mm)	B1 (mm)	B2 (mm)	P (mm)	AD (mm)	AC (mm)
LPP40-20.5-1.5/2	340	246	591	130	161	123	123	140	115	166
LPP40-17.5-1.1/2	340	246	546	130	161	123	123	120	96	148
LPP40-13-0.75/2	340	246	546	130	161	123	123	120	96	148

Base Plate Installation

Base Plate 1

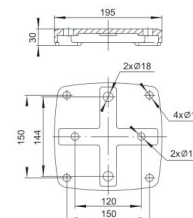

Model
LPP32-31-3/2
LPP32-26-2.2/2
LPP32-21-1.5/2
LPP32-16-1.1/2
LPP40-31-4/2
LPP40-24.5-3/2
LPP40-20.5-2.2/2
LPP40-20.5-1.5/2

Model
LPP40-17.5-1.1/2
LPP40-13-0.75/2
LPP50-34-5.5/2
LPP50-28-4/2
LPP50-24-3/2
LPP50-21-2.2/2
LPP50-16-1.5/2
LPP50-12-1.1/2

Base Plate 2

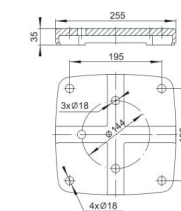

Model
LPP32-50-5.5/2
LPP32-40-4/2
LPP50-81-22/2
LPP50-70-18.5/2
LPP50-60-15/2
LPP50-80-11/2
LPP50-70-7.5/2
LPP50-60-7.5/2
LPP50-50-5.5/2
LPP50-40-4/2
LPP50-35-3/2

Model
LPP65-56-18.5/2
LPP65-49-15/2
LPP65-40-11/2
LPP65-35-7.5/2
LPP65-28-5.5/2
LPP65-21-4/2
LPP65-17-3/2
LPP65-14-2.2/2
LPP80-35-15/2
LPP80-28-11/2
LPP80-21.5-7.5/2
LPP80-20-5.5/2
LPP80-17-4/2
LPP80-14-3/2
LPP80-10.5-2.2/2
LPP80-8.5-1.5/2

Base Plate 3

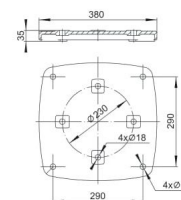

Model
LPP80-80-22/2
LPP80-70-18.5/2
LPP80-60-15/2
LPP80-28-11/4
LPP80-22-7.5/4
LPP80-19-5.5/4
LPP100-80-37/2
LPP100-70-30/2
LPP100-60-22/2
LPP100-50-22/2
LPP100-32-22/2
LPP100-32-22/4
LPP100-44-18.5/2
LPP100-30-18.5/2
LPP100-30-18.5/4
LPP100-38-15/2
LPP100-24-15/2

Model
LPP100-25-15/4
LPP100-21-11/4
LPP100-20-11/2
LPP100-16-7.5/4
LPP125-50-30/2
LPP125-44-30/2
LPP125-37.5-22/2
LPP125-35-30/4
LPP125-31-22/4
LPP125-28-18.5/4
LPP125-24-15/4
LPP125-19-11/4
LPP150-33-37/4
LPP150-29-30/4
LPP150-24.5-22/4
LPP150-21.5-18.5/4
LPP150-33-30/4
LPP150-25-22/4
LPP150-25-30/4

Base Plate Installation

Base Plate 4

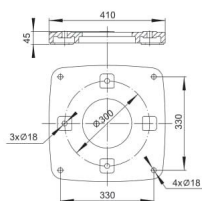

Model
LPP150-50-45/4
LPP150-40-37/4
LPP200-55-75/2
LPP200-36-75/4
LPP200-34-75/4
LPP200-44-55/4
LPP200-28-55/4
LPP200-38-45/4
LPP200-22.5-45/4
LPP200-32-37/4

Model
LPP200-18-37/4
LPP200-15-30/4
LPP200-18-18.5/4
LPP200-15-15/4

Base Plate 5

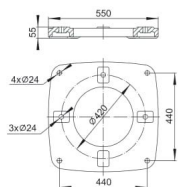

Model
LPP250-50-132/4
LPP250-50-110/4
LPP250-40-110/4
LPP250-44-90/4
LPP250-37-75/4

Pedestal Installation

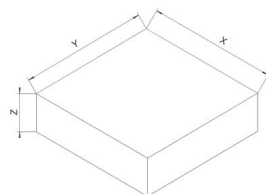

Model	Weight (kg)	X (mm)	Y (mm)	Z (mm)
LPP50-81-22/2	245	670	670	330
LPP50-70-18.5/2	206	670	670	330
LPP50-60-15/2	158	565	565	280
LPP65-56-18.5/2	186	565	565	280
LPP65-49-15/2	180	565	565	280
LPP65-40-11/2	176	565	565	280
LPP80-35-15/2	187	565	565	280
LPP80-28-11/2	173	565	565	280
LPP80-21.5-7.5/2	128	565	565	280
LPP80-28-11/4	238	670	670	330
LPP80-22-7.5/4	181	565	565	280
LPP80-19-5.5/4	168	565	565	280
LPP80-80-22/2	265	710	710	360

Pedestal Installation

Model	Weight (kg)	X (mm)	Y (mm)	Z (mm)
LPP80-70-18.5/2	220	670	670	330
LPP80-60-15/2	178	565	565	280
LPP100-50-22/2	267	710	710	360
LPP100-44-18.5/2	222	670	670	330
LPP100-38-15/2	180	565	565	280
LPP100-80-37/2	341	750	750	375
LPP100-70-30/2	330	750	750	375
LPP100-60-22/2	276	710	710	360
LPP100-32-22/2	330	750	750	375
LPP100-30-18.5/2	293	710	710	360
LPP100-24-15/2	270	710	710	360
LPP100-20-11/2	256	670	670	330
LPP100-32-22/4	345	750	750	375
LPP100-30-18.5/4	327	750	750	375
LPP100-25-15/4	286	710	710	360
LPP100-21-11/4	261	670	670	330
LPP100-16-7.5/4	222	670	670	330
LPP125-35-30/4	415	780	780	390
LPP125-31-22/4	352	750	750	375
LPP125-28-18.5/4	335	750	750	375
LPP125-24-15/4	305	710	710	360
LPP125-19-11/4	286	710	710	360
LPP125-50-30/2	347	750	750	375
LPP125-44-30/2	346	750	750	375
LPP125-37.5-22/2	290	710	710	360
LPP150-50-45/4	634	970	970	470
LPP150-40-37/4	570	870	870	440
LPP150-33-37/4	503	840	840	420
LPP150-29-30/4	475	840	840	420
LPP150-33-30/4	459	840	840	420
LPP150-25-22/4	377	780	780	390
LPP150-25-30/4	457	840	840	420
LPP150-24.5-22/4	410	780	780	390
LPP150-21.5-18.5/4	390	780	780	390
LPP150-21-18.5/4	346	750	750	375
LPP150-17-15/4	311	750	750	375
LPP150-12.5-11/4	293	710	710	360
LPP200-36-75/4	894	1050	1050	510
LPP200-34-75/4	860	1050	1050	510
LPP200-28-55/4	700	970	970	470
LPP200-22.5-45/4	570	870	870	440
LPP200-18-37/4	570	870	870	440
LPP200-15-30/4	531	870	870	440
LPP200-18-18.5/4	411	780	780	390
LPP200-15-15/4	376	780	780	390
LPP200-55-75/4	957	1050	1050	510
LPP200-44-55/4	762	970	970	470
LPP200-38-45/4	654	970	970	470
LPP200-32-37/4	633	970	970	470
LPP250-50-132/4	1608	1250	1250	620
LPP250-40-110/4	1512	1250	1250	620
LPP250-50-110/4	1512	1250	1250	620
LPP250-44-90/4	1134	1100	1100	550
LPP250-37-75/4	1092	1100	1100	550